

**IPCL V2.0 DATA SHEET**

*Doctor's Name : <input type="text"/>		*Patient's Name : <input type="text"/>				
*Hospital & City Name : <input type="text"/>		*Patient's id : <input type="text"/>				
*Email ID : <input type="text"/>		*Date of Birth : <input type="text"/>				
*Data Added By (Name) : <input type="text"/>						
*Operative Eye *Right (OD) *Left (OS)	<b>Refraction</b>	*Spherical <input type="text"/>	*Cylinder <input type="text"/>			
		*Axis <input type="text"/>	*Addition <input type="text"/>			
		*BCVA <input type="text"/>				
<b>Keratometry</b>	Power	Axis				
	K1 (Flat) <input type="text"/>	<input type="text"/>	*ACD from Endo <input type="text"/>			
	K2 (Steep) <input type="text"/>	<input type="text"/>	*Pachy <input type="text"/>			
	Axial Length(mm)					
	Opt : <input type="text"/>		*SIA <input type="text"/>			
	US : <input type="text"/>		*Ins Loc <input type="text"/>			
<b>W to W</b>	Digital <input type="text"/>	Optical <input type="text"/>	IOL Mast <input type="text"/>			
	Orb Scan <input type="text"/>	S to S <input type="text"/>				
<b>IPCL* SELECTION</b>	<input type="button" value="SPHERICAL"/>	<input type="button" value="TORIC"/>	<input type="button" value="PRESBYOPIC"/>			
	<input type="button" value="PRESBYOPIC-TORIC"/>					
<b>IPCL* Model</b>	Calculated Powers				Residual Powers	
	Spherical	Cylinder	Axis	Addition	Spherical	Cylinder
<input type="text"/>	<input type="text"/>	<input type="text"/>	<input type="text"/>	<input type="text"/>	<input type="text"/>	<input type="text"/>
<input type="text"/>	<input type="text"/>	<input type="text"/>	<input type="text"/>	<input type="text"/>	<input type="text"/>	<input type="text"/>
<input type="text"/>	<input type="text"/>	<input type="text"/>	<input type="text"/>	<input type="text"/>	<input type="text"/>	<input type="text"/>
		<p><b>Disclaimer :</b> The IPCL Lens Calculator will assist physicians in selecting the appropriate IOL for a patient. It is intended to be used in conjunction with a comprehensive ophthalmic examination and the appropriate diagnostic tests and measurements. We have taken utmost care to give the best result. The Physicians who use the calculator must arrive at their own independent determinations regarding the proper treatment for their patients. Care group is not responsible for any claims you may have arising out of your use of this tool. One PI @ 12 O'clock Position is recommended.</p>				
*Note : Lens Placement must be at 0-180 degrees.		<p><b>Online IPCL Calculator :</b> <a href="http://www.calc.ipcliol.com">www.calc.ipcliol.com</a></p>				

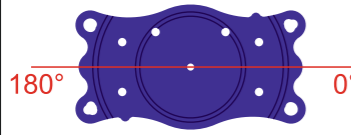
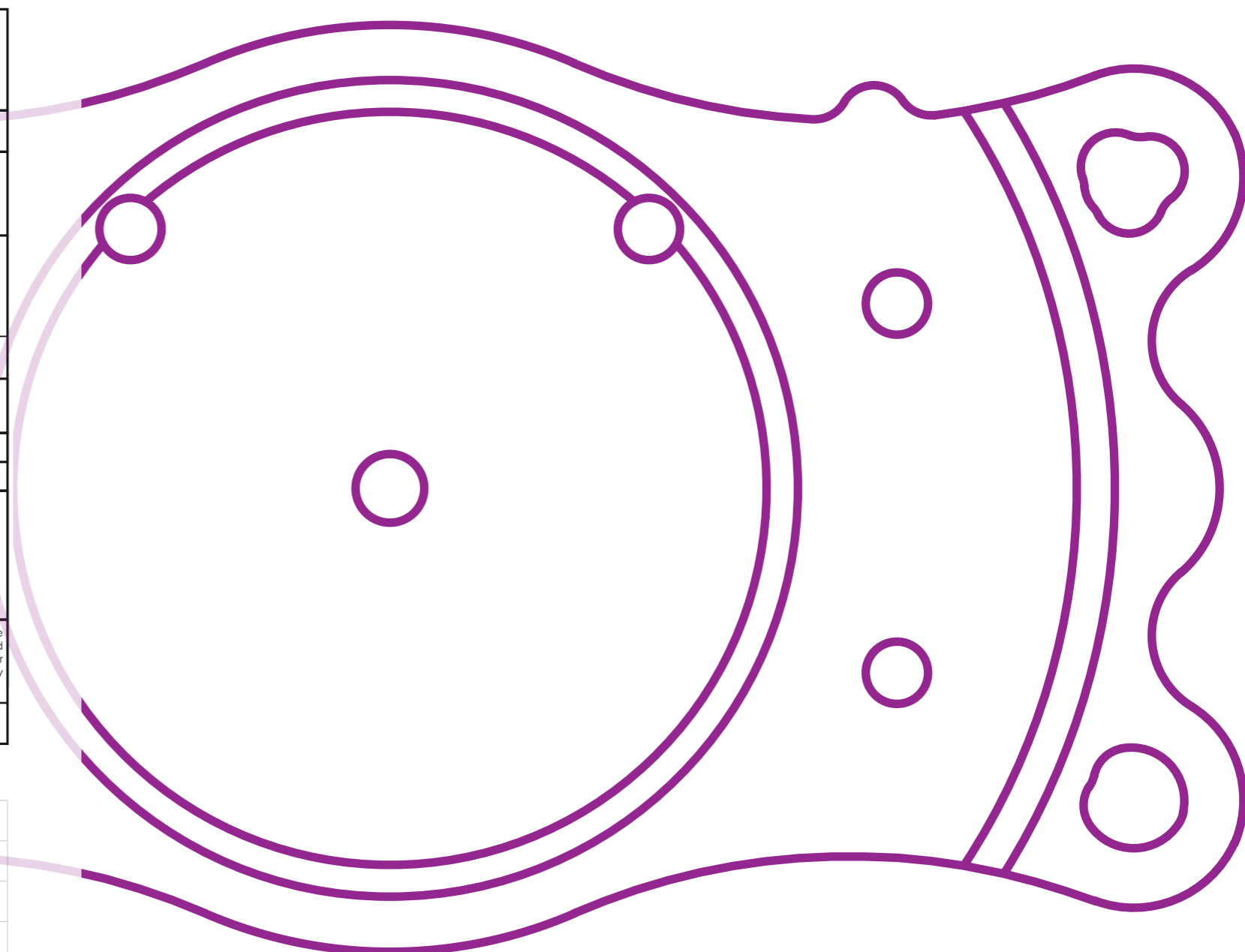

**IPCL V2.0 technical characteristics**

Materials	: Hybrid Hydrophilic Acrylic
Overall Diameter	: 11.00 mm to 14.00 mm ( in 0.25 mm steps )
Optical Diameter	: 6.6 mm
Clear Optic	: 5.5 mm to 4.6 mm
Refractive index	: 1.465
Abbe number	: 60
Vault height	: 1.20 mm to 1.75 mm
Standard diopter range	: -0.5 D to -22 D Myopia and +0.5 D to +6 D Hyperopia ( in 0.5 D increments )
Custom diopter range	: -22.5 D to -30 D Myopia and +6.5 D to +15 D Hyperopia ( in 0.5 D increments )
Standard cylinder range	: +0.5 D to +6.0 D ( in 0.5 D increments )
Custom cylinder range	: +6.5 D to +10 D ( in 0.5 D increments )
Presbyopic Addition	: +1.0 D to +4.0 D ( in 0.5 D increments )
Incision size	: 2.8 mm
Sterilization Method	: Steam

**The One Step Refractive Solution**

for Myopia, Hyperopia and Presbyopia with Astigmatism Correction

**Precise | Safe | Reversible**



**IMPLANTABLE**  
**PHAKIC** Contact Lens



## The One Step Refractive Solution for Myopia, Hyperopia and Presbyopia with Astigmatism Correction



### IPCL V2.0 Monofocal

- For Myopia and Hyperopia Correction
- Central Hole
- Aberration Controlled Optic
- No Light Scattering

### IPCL V2.0 Toric

- For Myopia and Hyperopia with Astigmatism Correction
- Central Hole
- Aberration Controlled Optic
- No Light Scattering
- Smart Toric Design
- No Rotation

### IPCL V2.0 Presbyopic

- For Presbyopia Correction
- Trifocal Optic ( For Near, Intermediate & Far Vision )
- Central Hole
- Aberration Controlled Optic
- No Light Scattering

### IPCL V2.0 Presbyopic Toric

- For Presbyopia with Astigmatism Correction
- Trifocal Optic ( For Near, Intermediate & Far Vision )
- Central Hole
- Aberration Controlled Optic
- No Light Scattering
- Smart Toric Design
- No Rotation

- Depending up on the patient's condition and the accommodation capacity of the lens, personalized solution can be offered for any particular patient.
- The lens has a patented refractive-diffractive trifocal design, ensuring good vision at far, intermediate and near focuses.
- With the choice of different near vision additions, adaptation to the accommodation capacity and the condition of the patient is possible.
- Over 2000 implantations of the presbyopic IPCL V2.0 worldwide.

Precise | Safe | Reversible

## One year clinical outcomes of presbyopia patients using Presbyopic IPCL.

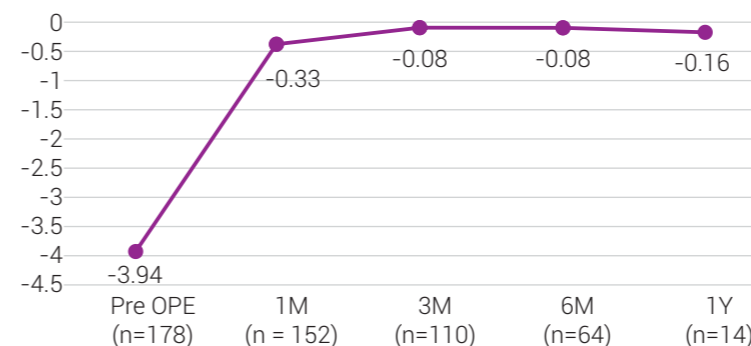

Refraction was significantly improved after surgery

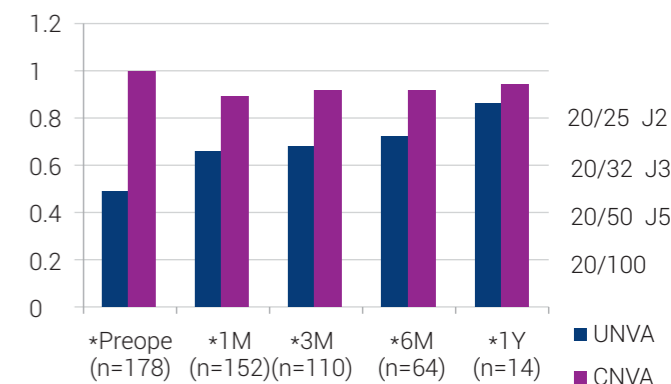

UNVA significantly improved from J5 preoperatively to J2 at 1 year postoperative.

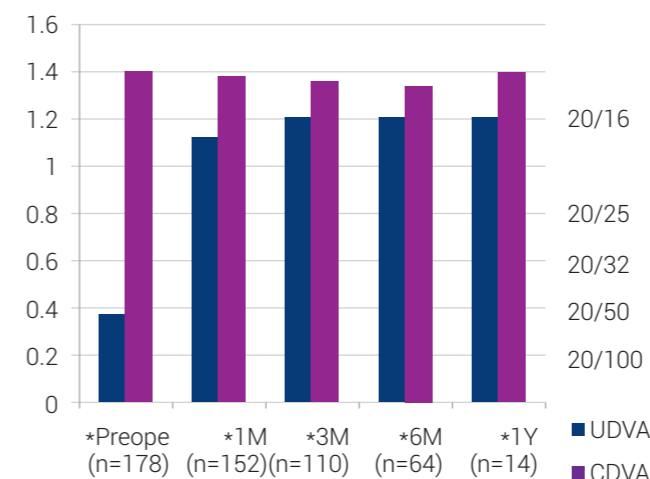

Mean of UDVA significantly improved from 20/54 preoperatively to 20/20 at 1 year postoperative.

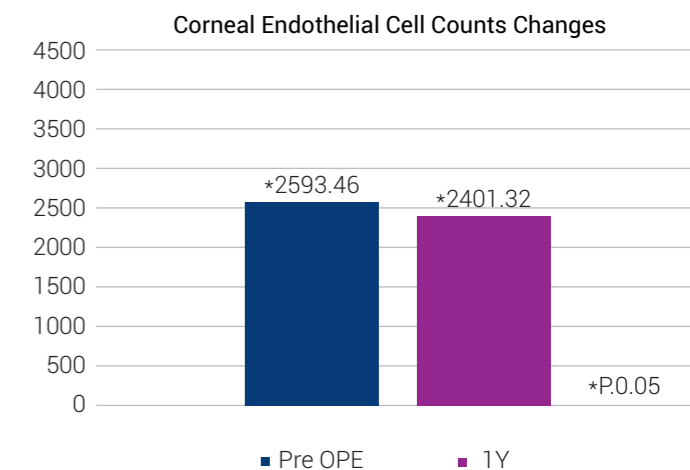

There was no significant difference in the endothelial cell counts between preoperative and 1 year postoperative.

- Very Satisfied
- Satisfied
- Not Satisfied

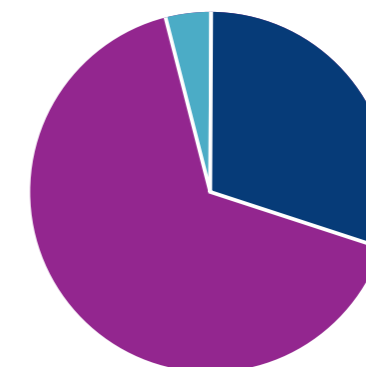

96% of patients were satisfied after the surgery, only 4% were unsatisfied.



## Long-term safety of posterior chamber IPCL for the correction of myopia

## IPCL V2.0 innovative design

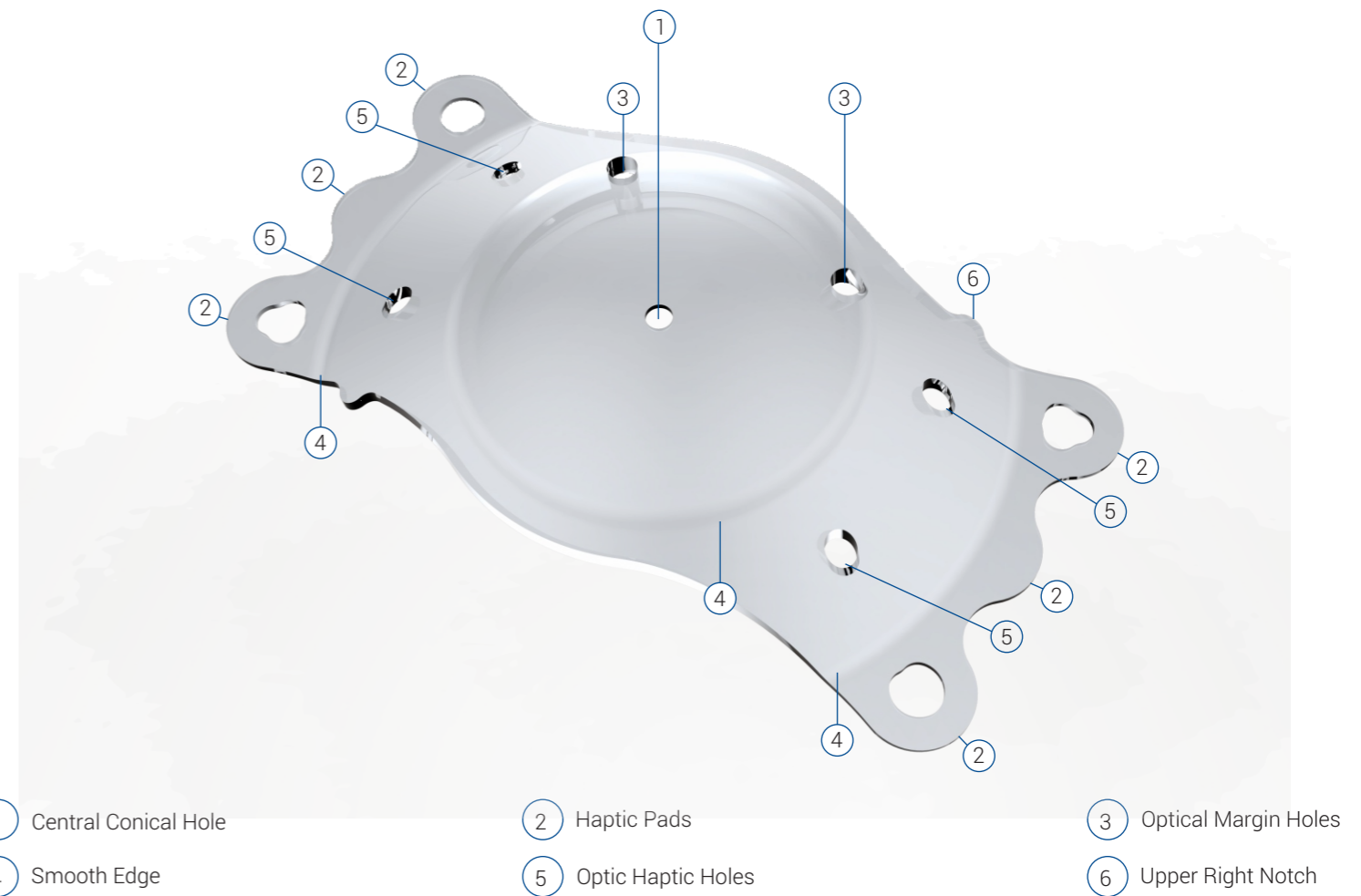
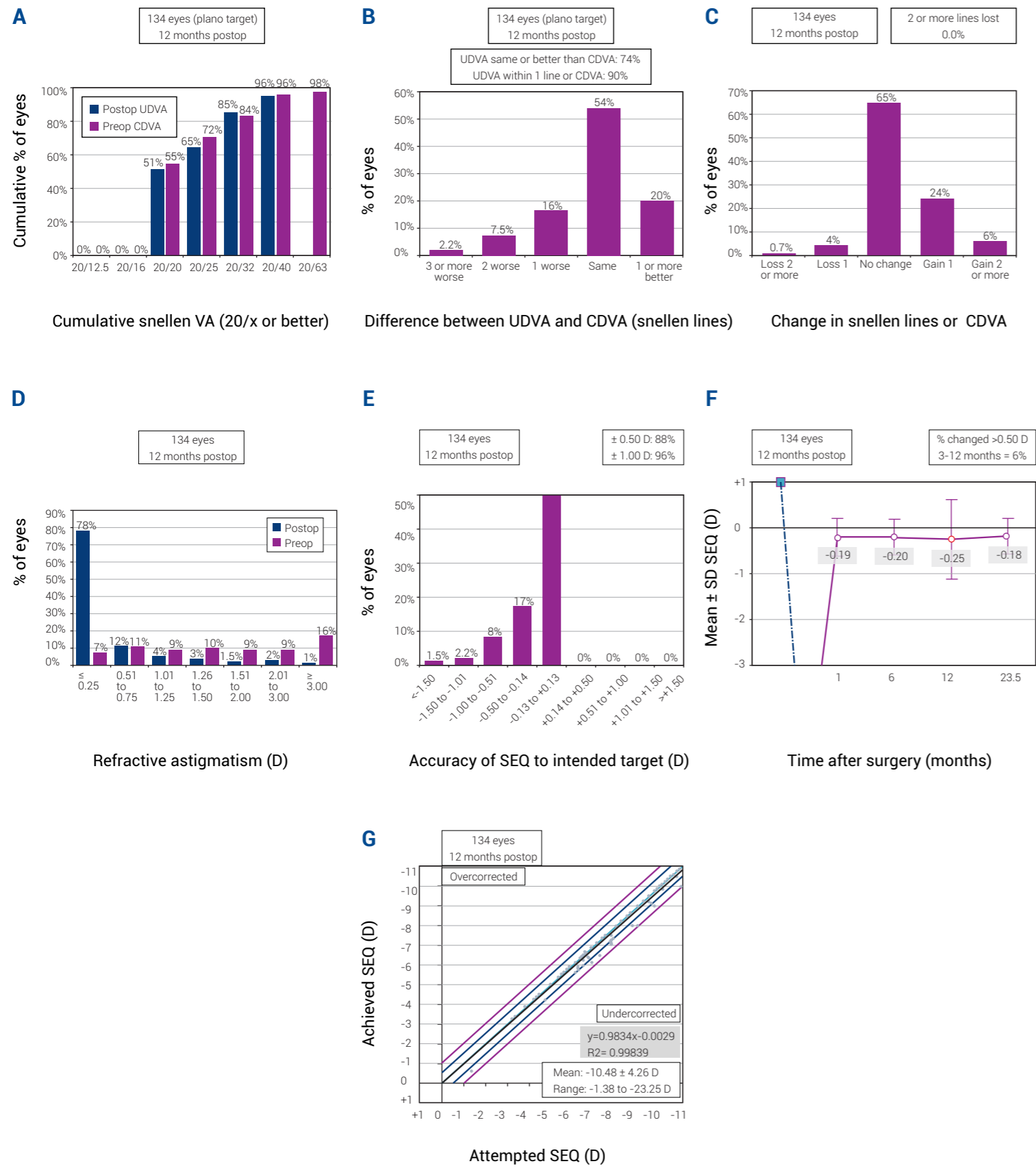

- Innovative central conical hole design to optimize aqueous flow and minimize light scattering and disturbances. ①
- Innovative 3 Haptic Pad Design for better stability in sulcus. ②
- Innovative spring haptic pads for more accurate white to white sizing. Angled optic - haptic ensures optimal distance (vaulting) from the natural lens. ②
- Optical Margin Holes ensures uninterrupted anterior chamber aqueous flow. The holes are in an upper position in order to avoid light reflexes or scattering. ③
- Lenses are uniquely designed with ultra smooth edges which have been thinned to eliminate Iris Pigmentation. ④
- The four optic haptic holes are designed to provide additional aqueous flow to reduce IOP. ⑤
- Haptic markings and notches aid orientation during lens positioning and loading of the lens in the cartridge. ③ ⑥

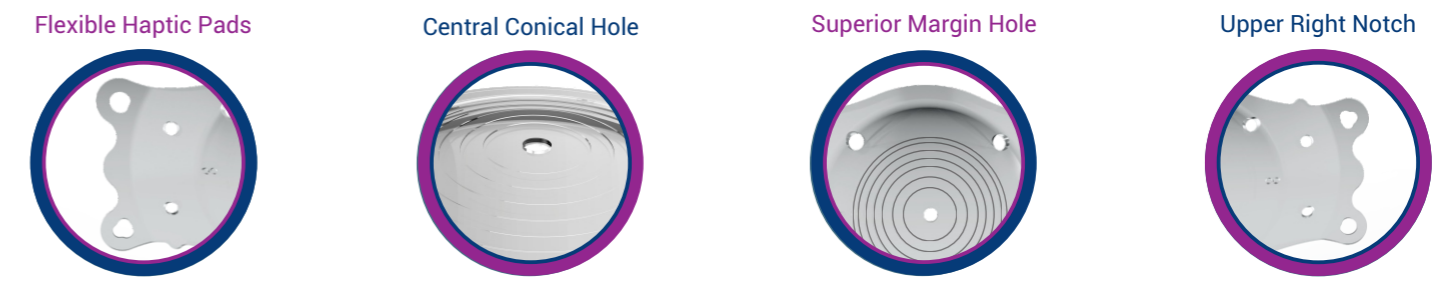

**Figure I** Refractive outcomes following IPCL implantation. **Notes:**(A) UDVA, (B) UDVA vs CDVA, (C) Change in CDVA, (D) Spherical equivalent refraction attempted vs achieved. (E) Spherical equivalent refraction accuracy, (F) Spherical equivalent refraction stability, (G) Refractive astigmatism. **Abbreviations:** CDVA - Corrected distance visual acuity; IPCL - Implantable phakic contact lens; Preop - preoperative; Postop - Postoperative; SEQ - Spherical Equivalent; UDVA - Uncorrected distance visual acuity.

**Note** - Some of the lenses implanted in the references were IPCL V1.0 model, current model available is IPCL V2.0



### IPCL V2.0 Visual Correction offering the highest quality

#### Performance

- High quality vision correction
- Invisible in the eye
- Preservation of accommodation capacity
- No corneal tissue removed
- High-level long-term stability
- No regression
- Preservation of corneal asphericity

#### Why Use IPCL V2.0?

- Simple user friendly Injection system
- Extensive diopter range
- Rapid recovery
- Unique presbyopic model available
- Predictable and reliable results
- High level of patient satisfaction
- No induced dry eyes
- Suitable for all types of corneas including thin corneas
- Attractive solution for patients who are highly myopic and presbyopic

#### The Key to Success

- Patient selection
- Accurate eye measurements
- Patient counselling
- Training of practice personnel
- Counsellor of surgeons, OR- and practice personnel

#### Main Properties

- Outstanding depth of focus
- Best contrast vision possible
- No induced spherical or chromatic aberration
- Correction of astigmatism and presbyopia
- Broad range of individual solutions for all kinds of visual defects

Note - IPCL V2.0 is currently being implanted in more than twenty four countries around the world

### IPCL V2.0 features

- IPCL V2.0 is a hydrophilic, one-piece implantable posterior chamber lens which can be implanted through a 2.8 mm incision.
- The lenses are manufactured from a hybrid hydrophilic acrylic biocompatible material with proven long term safety results.
- Largest dioptric range available on the market, customization up to -30 diopters.
- All IPCL V2.0 lenses are aspheric and available for myopia, hyperopia, presbyopia with astigmatism correction.
- Smart Toric IPCL V2.0 design is customized for every lens on 0° - 180° axis placement, only reference marking required and no rotation needed.
- Customized larger optics are available up to 7.25 mm.
- The unique patented refractive - diffractive trifocal optic has an effective light transmission.
- IPCL V2.0 provides excellent contrast sensitivity.

### IPCL V2.0 Position Inside the Eye

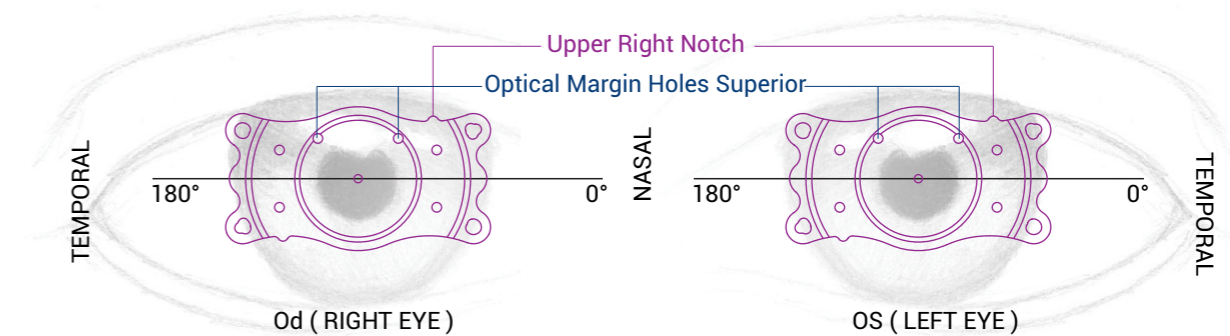

#### REFERENCES

- Refractive and visual outcomes with diffractive posterior chamber implantable phakic contact lens (IPCL) for presbyopia treatment: one year follow up. M Tomita, Japan, MD, Minoru Tomita Eye Clinic, Tokyo, Japan.
- A new implantable phakic intraocular lens ( IPCL ) : a preliminary report. S. Patwardhan, India. Nandadeep Eye Hospital and Institute, Sangli, Maharashtra, India.
- IPCL ( Implantable phakic contact lens) results in refractive correction of myopic and hypermetropic eyes. J Thind, India. Thind Eye Hospital, Jalandhar, Punjab, India.